



Thyristors type P83 are of modern design with pressure contacts, high alumina ceramic insulator and cold-welding encapsulation. Designed for use in power electronic circuits and equipment under normal operating conditions.

### KEY PARAMETERS

$U_{DRM}, U_{RRM}$	<b>up to 1400 V</b>
$I_{T(AV)}$	<b>600 A</b>
$I_{TSM}$	<b>9600 A</b>
$du/dt^*$	<b>1000 V/<math>\mu</math>s</b>
$di/dt$	<b>400 A/<math>\mu</math>s</b>

\* maximum (non standard) value

### FEATURES

- all diffused design
- high current capabilities
- high surge current capabilities
- low turn-off time values
- guaranteed  $di/dt$
- high rates voltages
- high  $du/dt$
- low gate current
- interdigitated dynamic gate
- low thermal impedance
- tested according to IEC standards
- compact size and small weight

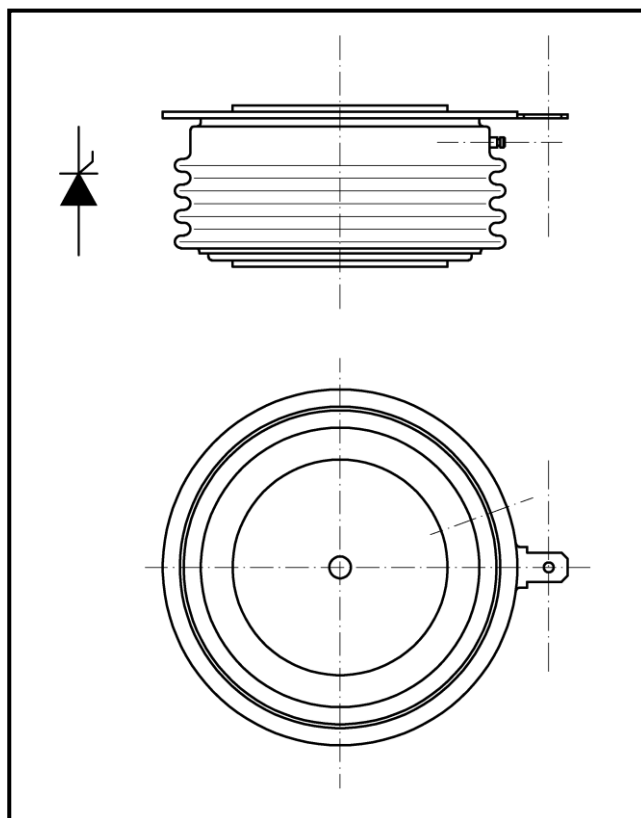

### APPLICATION

- High Frequency Inverters
- Induction Heating Inverters
- Uninterruptable Power Supplies

Designed for use in high power industrial and commercial electronic circuits and equipment where high currents are encountered and high reliability is essential.

**Outline type code: JEDEC TO-200AC**  
See package details for further information

# P83-600

## Inverter Type Thyristor



Zakłady Elektronowe  
**LAMINA S.A.**

KKP83600, July 2005 version

### ORDERING INFORMATION

When ordering please refer to device code builder presented below.  
Please use the complete part number when ordering, quote or in any future correspondence relating to your order.

**P83-600-□□**

└── voltage class (hundreds of volts)

This is standard device, with no dynamic parameters specified and standard accessory set.  
Please refer to **Electrical Parameters** if specific dynamic demands have to be met.  
Those information, as well as any other concerning non-standard accessories e.g. custom leads length or lead terminal connector type should be included in the order.

### ELECTRICAL PARAMETERS

#### Voltage ratings

Voltage class	$U_{DRM}, U_{RRM}$	$U_{DSM}, U_{RSM}$	$I_{DRM}, I_{RRM}$
	V	V	mA
08	800	900	50
10	1000	1100	
12	1200	1300	
14	1400	1500	

#### dU/dt group codes

Group code	du/dt
	V/μs
0	no specified value
5	320
6	500
7	1000

Zakłady Elektronowe LAMINA S.A.  
Puławska 34  
PL-05-500 Piaseczno  
POLAND

Tel.: +48-22-7572731  
Tel.: +48-22-3989409  
Fax.: +48-22-3989407  
e-mail: sekretariat@lamina.com.pl  
www.lamina.com.pl

# P83-600

## Inverter Type Thyristor



Zakłady Elektronowe  
**LAMINA S.A.**

KKP83600, July 2005 version

### Electrical properties

Parameter		Unit	Test conditions	Value
Average on-state current @ case temperature	$I_{T(AV)}$	A		600
	$T_c$	°C		75
RMS on-state current	$I_{T(RMS)}$	A		940
Surge current	$I_{TSM}$	A	$T_j=125^\circ\text{C}$ , $U_R=0,8U_{RRM}$ , $t_p=10\text{ms}$	9600
$I^2t$ – value	$I^2t$	$\text{kA}^2\text{s}$		460
On-state voltage drop max.	$U_{TM}$	V	$T_j=25^\circ\text{C}$ , $I_{TM}=1500\text{A}$	2,0
Threshold voltage	$U_{T(T0)}$	V		1,20
Slope resistance	$r_T$	$\text{m}\Omega$		0,520
Latching current	$I_l$	mA	$T_j=25^\circ\text{C}$ , $U_D=12\text{V}$	1000
Holding current	$I_H$	mA	$T_j=25^\circ\text{C}$ , $U_D=12\text{V}$	300
Circuit commutated turn-off time	$t_q$	$\mu\text{s}$	$T_j=125^\circ\text{C}$ , $I_{TM}=250\text{A}$ , $di_R/dt=25\text{A}/\mu\text{s}$ , $du/dt=20\text{V}/\mu\text{s}$ , $U_D=0,67U_{DRM}$ , $U_{RM}=100\text{V}$	20 for voltage class up to 12 32 for voltage class 14
Turn-On time (typical)	$t_{on}$	$\mu\text{s}$	$I_{TM}=100\text{A}$ , $U_{DM}=100\text{V}$	4
Rate of rise of on-state current-repetitive	$di/dt$	$\text{A}/\mu\text{s}$	$T_j=125^\circ\text{C}$ , $I_{TM}=3I_{T(AV)}$ , $U_D=0,67U_{DRM}$ , $f=50\text{Hz}$ , $I_{GM}=1\text{A}$ , $di_G/dt=1\text{A}/\mu\text{s}$	400
Critical rate of raise of off-state voltage	$du/dt$	$\text{V}/\mu\text{s}$	$T_j=125^\circ\text{C}$ , $U_D=0,67U_{DRM}$	320 – 1000 (see $du/dt$ group codes)
Gate current to trigger	$I_{GT}$	mA	$T_j=25^\circ\text{C}$ , $U_D=12\text{V}$	200
Gate voltage to trigger	$U_{GT}$	V	$T_j=25^\circ\text{C}$ , $U_D=12\text{V}$	3

### Thermal properties

Parameter		Unit	Test conditions	Value
Thermal resistance, junction to case	$R_{thJC}$	°C/W	two sided, DC	0,037
Thermal resistance, case to heatsink	$R_{thCS}$	°C/W	two sided	0,020
Operating junction temperature	$T_{jmin} \dots T_{jmax}$	°C		-40...+125
Storage temperature	$T_{stg}$	°C		-40...+125

### Mechanical properties

Parameter		Unit	Value
Clamping force	$F_M$	kN	12,0 ... 14,0
Weight	m	g	260

Zakłady Elektronowe LAMINA S.A.  
Puławska 34  
PL-05-500 Piaseczno  
POLAND

Tel.: +48-22-7572731  
Tel.: +48-22-3989409  
Fax.: +48-22-3989407  
e-mail: sekretariat@lamina.com.pl  
www.lamina.com.pl

# P83-600

## Inverter Type Thyristor

KKP83600, July 2005 version

### Package details

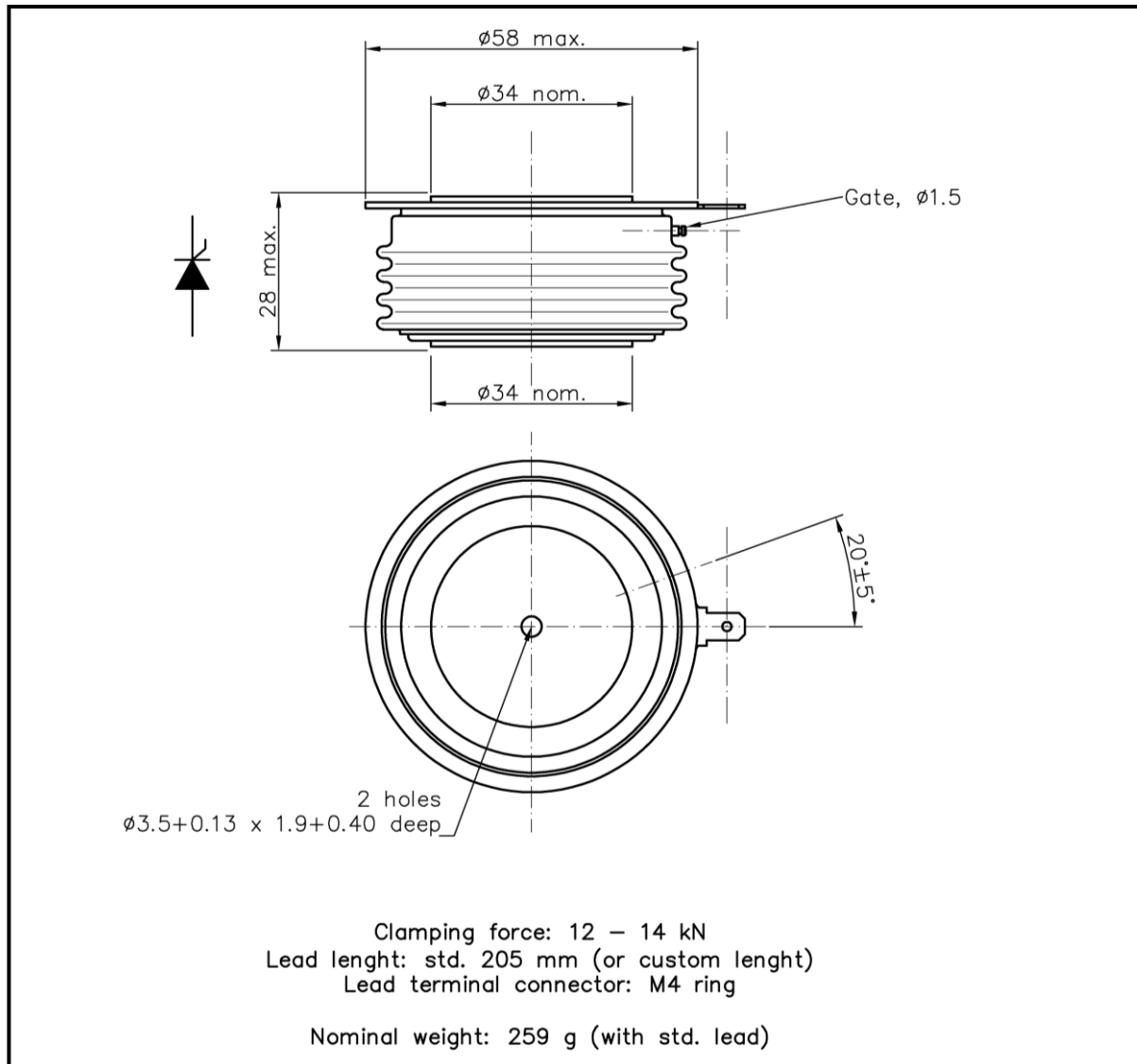

For further package information, please contact Sales & Marketing Department. All dimensions in mm, unless stated otherwise.

Do not scale.

# P83-600

## Inverter Type Thyristor



KKP83600, July 2005 version

### CHARACTERISTICS

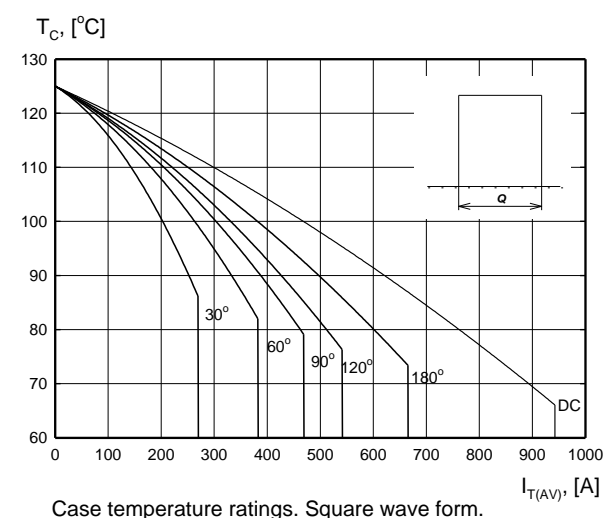
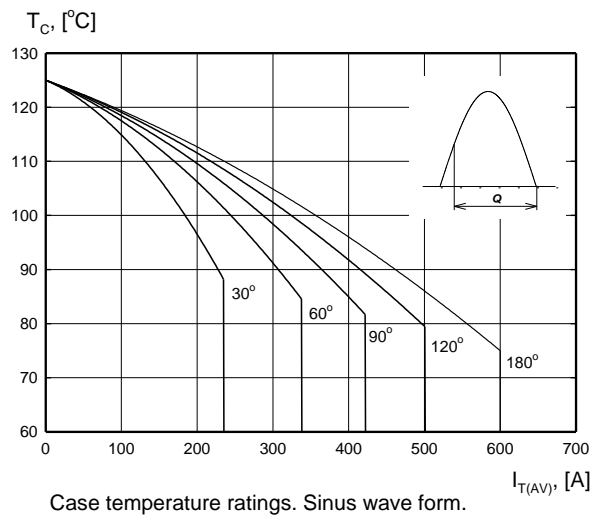
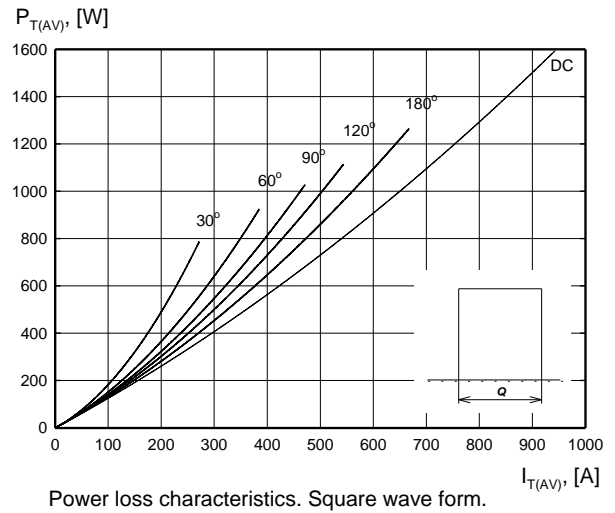
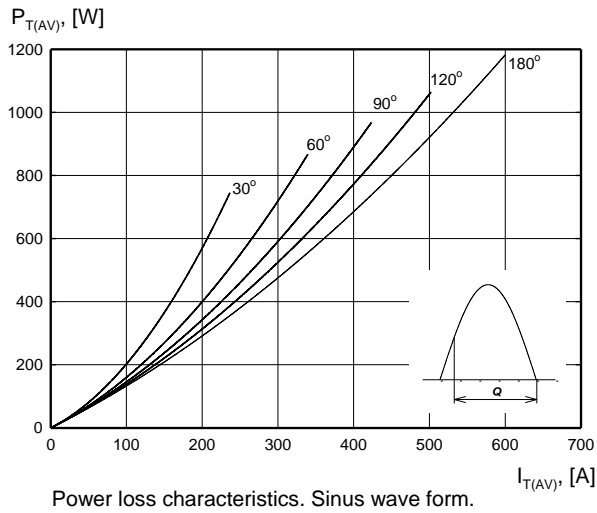

Zakłady Elektronowe LAMINA S.A.  
 Puławska 34  
 PL-05-500 Piaseczno  
 POLAND

Tel.: +48-22-7572731  
 Tel.: +48-22-3989409  
 Fax.: +48-22-3989407  
 e-mail: sekretariat@lamina.com.pl  
 www.lamina.com.pl

# P83-600

## Inverter Type Thyristor

KKP83600, July 2005 version

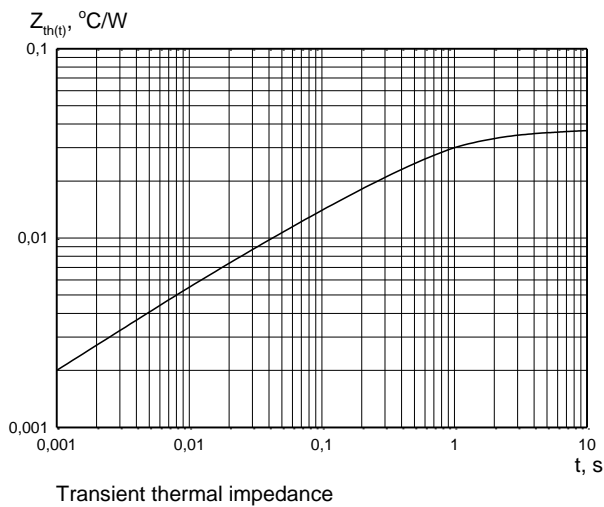
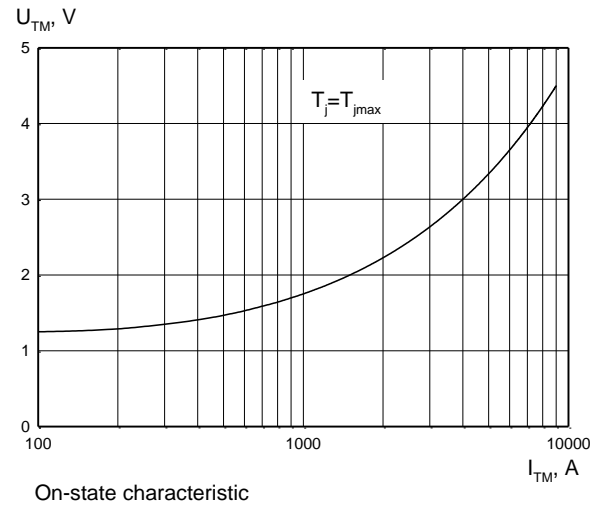
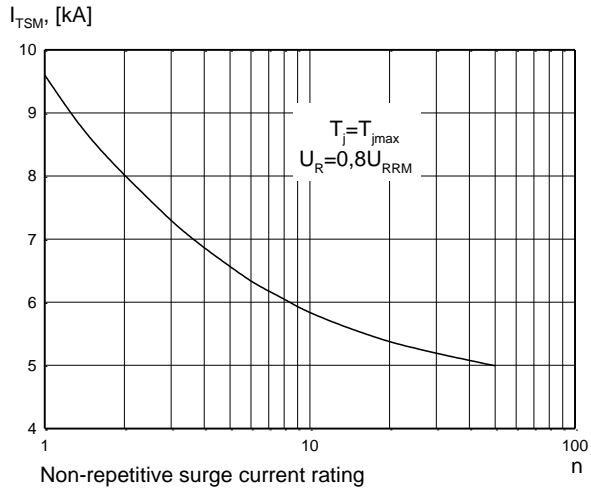

# P83-600

## Inverter Type Thyristor



Zakłady Elektronowe  
**LAMINA S.A.**

KKP83600, July 2005 version

### Frequency characteristics

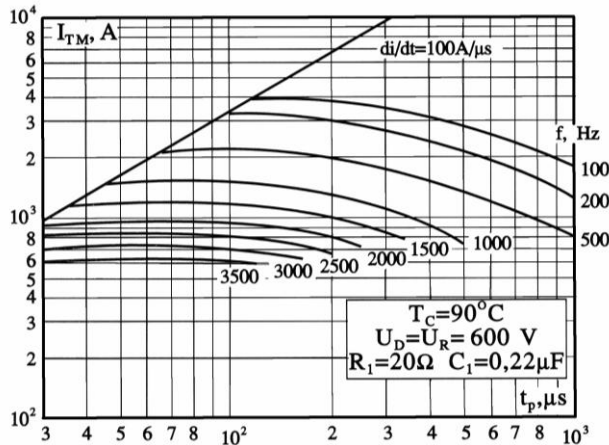

Frequency characteristics.  
Sinusoidal waveform,  $T_c=90^\circ\text{C}$

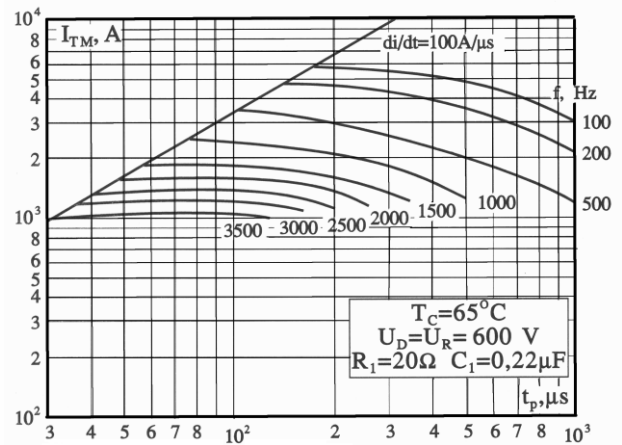

Frequency characteristics.  
Sinusoidal waveform,  $T_c=65^\circ\text{C}$

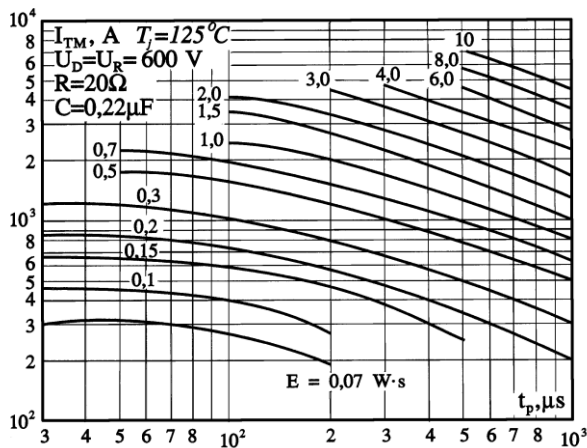

Maximum energy loss per pulse.

Zakłady Elektronowe LAMINA S.A.  
Puławska 34  
PL-05-500 Piaseczno  
POLAND

Tel.: +48-22-7572731  
Tel.: +48-22-3989409  
Fax.: +48-22-3989407  
e-mail: sekretariat@lamina.com.pl  
www.lamina.com.pl

# P83-600

## Inverter Type Thyristor

KKP83600, July 2005 version

### Gate characteristics

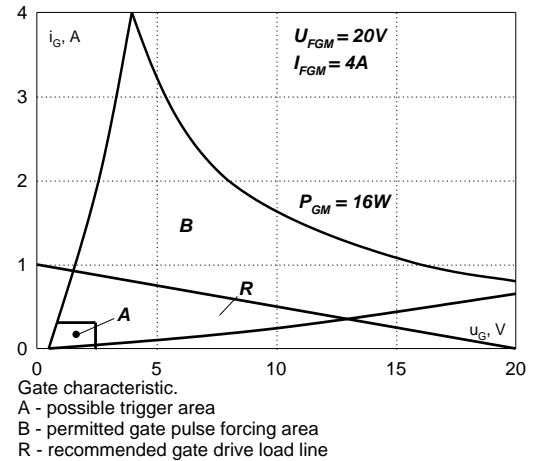
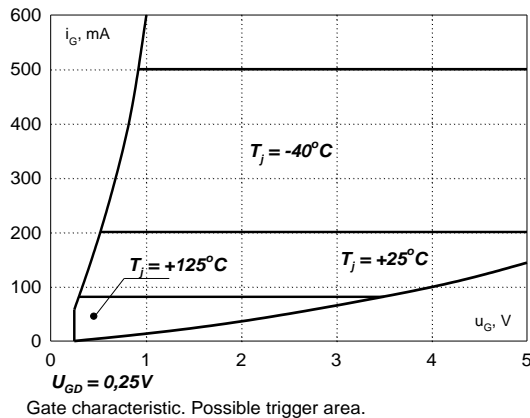

### HEATSINKS

LAMINA S.I. has its own proprietary range of extruded aluminium heatsinks designed to optimise the performance of our semiconductors with natural and forced air flow. High efficiency water cooled copper heatsinks are also available.

### DEVICE CLAMPS

Disc devices require the correct clamping force to ensure their best operation. LAMINA S.I. offers a wide selection of clamps to suit all of our manufactured devices.

### POWER ASSEMBLY CAPABILITY

LAMINA S.I. provides a support for those customers requiring more than a basic semiconductor and offers precisely assembled Power Blocks according to factory or customer standards.